

# Low Power Wireless Sensor Network for Building Monitoring

Tom Torfs, Tom Sterken, Steven Brebels, Juan Santana, Richard van den Hoven, Vincent Spiering, Nicolas Bertsch, Davide Trapani, and Daniele Zonta

**Abstract**—A wireless sensor network is proposed for monitoring buildings to assess earthquake damage. The sensor nodes use custom-developed capacitive microelectromechanical systems strain and 3-D acceleration sensors and a low power readout application-specified integrated circuit for a battery life of up to 12 years. The strain sensors are mounted at the base of the building to measure the settlement and plastic hinge activation of the building after an earthquake. They measure periodically or on-demand from the base station. The accelerometers are mounted at every floor of the building to measure the seismic response of the building during an earthquake. They record during an earthquake event using a combination of the local acceleration data and remote triggering from the base station based on the acceleration data from multiple sensors across the building. A low power network architecture was implemented over an 802.15.4 MAC in the 900-MHz band. A custom patch antenna was designed in this frequency band to obtain robust links in real-world conditions. The modules have been validated in a full-scale laboratory setup with simulated earthquakes.

**Index Terms**—Microelectromechanical systems (MEMS), remote monitoring, structural health monitoring, wireless sensor networks.

## I. INTRODUCTION

**B**UILDINGS can progressively accumulate damage during their operational lifetime, due to seismic events, unforeseen foundation settlement, material aging, design error, etc. Periodic monitoring of the structure for such damage is therefore a key step in rationally planning the maintenance needed to guarantee an adequate level of safety and serviceability. However, in order for the installation of a permanently installed sensing system in buildings to be economically

Manuscript received May 17, 2012; accepted September 2, 2012. Date of publication September 12, 2012; date of current version January 29, 2013. This work was supported by the MEMSCON Project, Funded by the European Commission FP7 under Contract 036887. The associate editor coordinating the review of this paper and approving it for publication was Dr. Ping Shum.

T. Torfs and S. Brebels are with IMEC, Leuven 3001, Belgium (e-mail: tom.torfs@imec.be; steven.brebels@imec.be).

T. Sterken is with the Centre for Microsystems Technology, University of Ghent, Ghent 9000, Belgium (e-mail: tom.sterken@imec.be).

J. Santana and R. van den Hoven are with the Holst Centre/IMEC, Eindhoven 5656AE, The Netherlands (e-mail: juan.santana@imec-nl.nl; richard.vandenhoven@imec-nl.nl).

V. Spiering is with Thermo Fisher Scientific, Enschede 7500 AE, The Netherlands (e-mail: vincent.spiering@thermofisher.com).

N. Bertsch is with MEMSCAP, Crolles 38 926, France (e-mail: nicolas.bertsch@memscap.com).

D. Trapani and D. Zonta are with the University of Trento, Trento 38122, Italy (e-mail: davide.trapani@ing.unitn.it; daniele.zonta@unitn.it).

Color versions of one or more of the figures in this paper are available online at <http://ieeexplore.ieee.org>.

Digital Object Identifier 10.1109/JSEN.2012.2218680

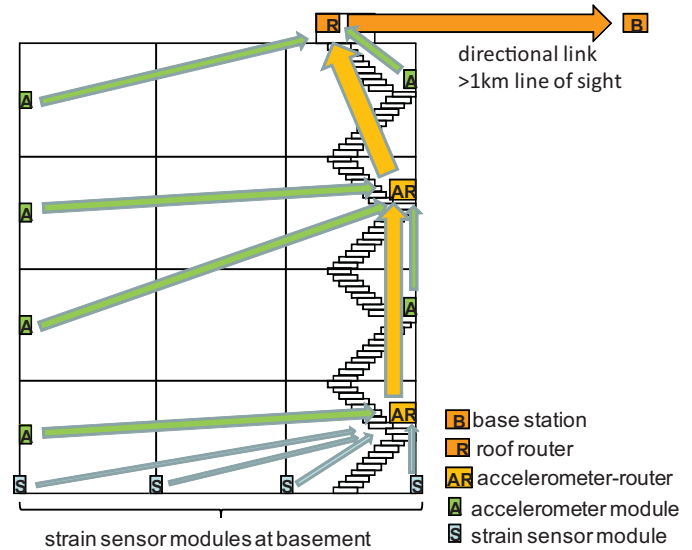

Fig. 1. Network architecture of the monitoring system in a building.

viable [1], the sensor modules must be wireless to reduce installation costs, must operate with a low power consumption to reduce servicing costs of replacing batteries, and use low cost sensors that can be mass produced such as MEMS sensors. The capability of MEMS and wireless networking for monitoring civil structures is well documented [2]–[4]. The presented work addresses all of the above requirements.

## II. SYSTEM ARCHITECTURE

### A. Network Architecture

The monitoring system consists of two types of sensor modules: strain sensing modules and acceleration sensing modules. They are placed in the building as shown in Fig. 1. The strain sensor modules are mounted at the lowest level of the building, to estimate the vertical column loads and to measure the settlement and plastic hinge activation of the building after an earthquake. Horizontal acceleration is measured by two 3D acceleration sensing modules (where only the two horizontal axes are really required) at each level during an earthquake, allowing analysis of the seismic response of the whole structure. A typical 7-story, 24-column building requires approx. 72 strain sensors (3 per column) and 14 accelerometer modules (2 per floor).

The data obtained by the sensor system is wirelessly transmitted to a nearby base station using a line of sight link with a range of > 1 km. The line of sight link uses

directional antennas to improve the link budget, but not so directional that alignment is required, which could pose a problem during seismic events. The receiver base station can store and process the data or forward them, immediately or later, using classical wide area network connection technology. In this way, provided all modules as well as the receiver base station have battery back-up power, the data acquired during seismic events can be properly recorded even in case of outages of the electric power and/or communication networks.

In order to form a robust wireless link from all modules, including the strain sensor modules at the basement of the building, towards the receiver base station, a multi-hop network architecture is used as shown in Fig. 1. On the roof of the building a dedicated router module (without sensor) is placed to forward the data between the sensor network and the receiver base station. Some accelerometer modules on intermediate floors can be configured as additional intermediate routers when required to obtain a robust link from all sensor modules in the building towards the roof router module. As shown on Fig. 1, it is recommended to place the router modules in or close to the stairwell for improved vertical floor-to-floor propagation through the building.

For lowest power consumption in the sensor modules, the network is implemented using indirect data transfer using polling on top of a standard 802.15.4 MAC. In this way, the end nodes' radio is powered down most of the time. Only the routers and base station have their receivers constantly on. To avoid rapid battery depletion, the modules with router functionality are mains-powered through an AC/DC adapter, with the battery serving only for back-up power in case mains power is interrupted. The end nodes (i.e. the large majority of installed sensor modules) are powered exclusively by their battery.

### B. MEMS Sensors

The MEMS accelerometer consists of 2 transverse comb finger structures for the X and Y axis and a pendulating one for the Z axis and was fabricated with a surface micro-machined process from a 85  $\mu\text{m}$  thick SOI wafer. It has 78 fingers with a total sensitivity of 2.02 pF/g. The Z sensor has an area of 2.17 mm<sup>2</sup> per plate. Innovative cap through connections were used. The main tradeoff in the design of the accelerometer is the sensitivity-bandwidth-linearity in all three axes, a challenge for the design given the different used structures. The XY and Z accelerometers are packaged together with the readout ASIC into a system-in-a-package and then mounted onto the printed circuit board as can be seen on Fig. 3.

The MEMS strain sensor is a longitudinal comb finger capacitor. The strain sensor fabrication procedure starts with a SOI wafer with a 500  $\mu\text{m}$  thick handle, 50  $\mu\text{m}$  thick fingers and 2  $\mu\text{m}$  thick oxide layer with 400 fingers in the sensor and it has a sensitivity of 0.133 fF/ $\mu\epsilon$ . Two anchors were etched-out of the surface to create the necessary clamps to attach the sensor to the rebar of a pillar. The fingers are protected with a borosilicate glass cap.

The use of custom-developed MEMS sensors and read-out ASIC allows to meet the specific requirements of the building

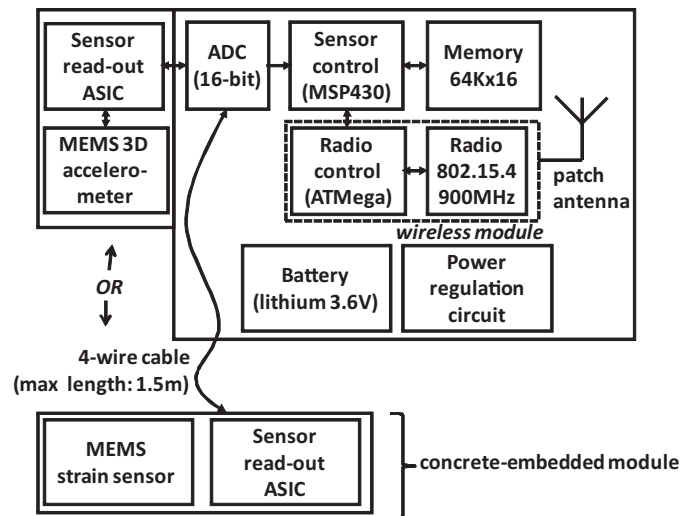

Fig. 2. Block diagram of a sensor module.



Fig. 3. Packaged accelerometer module with indication of axes.

monitoring application and differentiates the presented system from the earlier prototype system presented in [6] and [7].

### C. Sensor Module Architecture

The block diagram of the sensor modules is shown in Fig. 2. Both the accelerometer and strain sensing variants of the module use the same core components. For installation into the building these components are placed into a standard off-the-shelf plastic casing (see Fig. 3) that can be conveniently mounted on the floor, wall or ceiling using screws, and offering access for sporadic battery replacement if needed. The core components are:

- 1) A custom-developed low power capacitive sensor read-out ASIC [5]. This ASIC can be matched to either MEMS-based comb finger capacitive accelerometers or strain sensors in a half-bridge configuration. Its gain can be set by a number of integration pulses  $N$ , optimizing signal-to-noise ratio and bandwidth with power. In addition, the architecture suppresses residual motion artifacts. In combination with the MEMS strain sensor, it can measure a range of  $\pm 20\,000 \mu\epsilon$  with a resolution of 10  $\mu\epsilon$  and non-linearity  $<0.6\%$ . In combination with

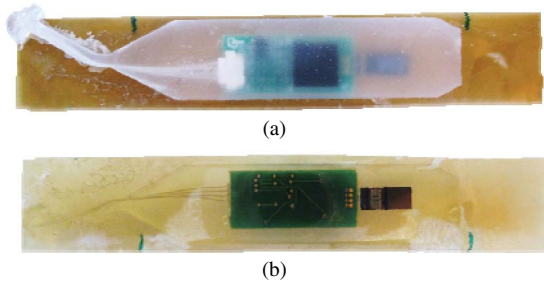

Fig. 4. Strain sensor front-end module on polyimide carrier. (a) Top view. (b) Bottom view.

the MEMS accelerometer it can measure an acceleration range of  $\pm 2.5$  g with a resolution of 80 dB (13-bit) for vibrations between 10–100 Hz and a non-linearity  $< 1\%$ .

- 2) A low power 16-bit successive-approximation analog-to-digital converter (Analog Devices AD7683).
- 3) A low power microcontroller (TI MSP430) to control the sensor data acquisition and temporarily store the data in a  $64\text{ K} \times 16$  bit SRAM memory (Cypress CY62126).
- 4) A low power wireless IEEE 802.15.4-compatible module (Atmel ATZB-900) operating in the 900 MHz band. This frequency band was chosen in preference to the more common 2.4 GHz band because it offers a larger propagation range for the wireless communication. The wireless module includes a radio chip (Atmel AT86RF212) and a baseband microcontroller (Atmel AVR) which needs to be active only during wireless communication events. The radio communication capability throughout the building has been successfully shown using these radio modules using the prototypes from [6] and [7].
- 5) A custom patch antenna was designed for the modules. The patch antenna is tuned for 868 MHz operation with an efficiency of 51% using standard FR4 material as the substrate. Its size is  $5 \times 5 \times 1.3$  cm<sup>3</sup>. Its shape and radiation pattern is optimized for wall-, floor- and ceiling-mounting in the building.
- 6) The modules are powered by a an 8.5Ah C-cell long operating life primary Lithium Thionyl Chloride battery (Tadiran SL-2770), suitable for 10 to 25 years of operation.

#### D. Strain Sensing Front-End Module

The MEMS strain sensor is packaged together with the readout ASIC into a special front-end strain sensing module (Fig. 4) which is embedded inside the reinforced concrete onto the reinforcing bar, preferably prior to the pouring of the concrete. As shown in Fig. 5, the sensor is mounted on a polyimide carrier which in turn is glued onto the reinforcing bar. A variant of this package exists in which the carrier is thin steel, which offers the additional possibility for welding the carrier to the reinforcing bar. The module is molded in PDMS silicone to protect the components from the environment during installation and pouring of concrete, while remaining a mechanically compliant package to avoid distorting the strain

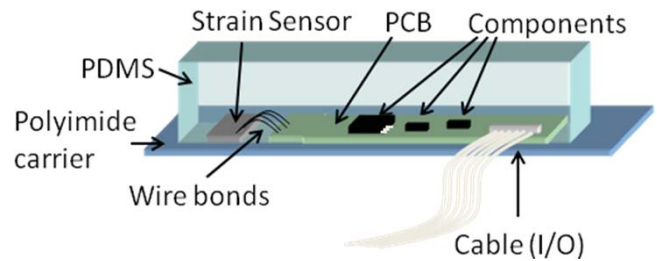

Fig. 5. Drawing of strain sensor front-end module indicating the components.

#### Monitoring nodes

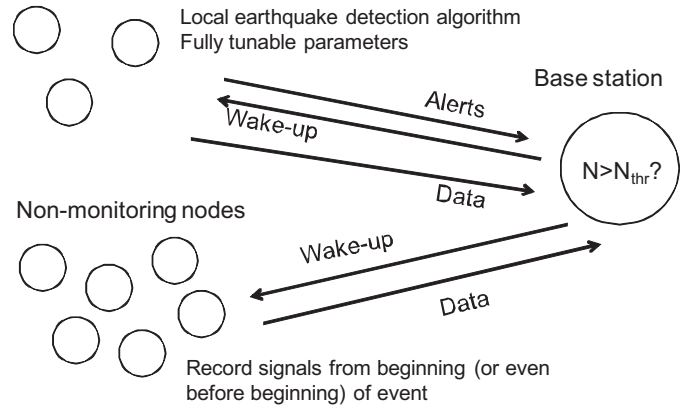

Fig. 6. Diagram of distributed earthquake wake-up procedure.

sensor measurement. This front-end strain sensing module is connected to the rest of the module through a small 4-wire cable with a maximum length of 1.5 m.

#### E. Measurement Initiation

1) *Accelerometer Modules*: The main trigger for the recording of an acceleration measurement is the detection of the start of an earthquake. The detection is done using a distributed earthquake detection mechanism as shown in Fig. 6. When the output of the built-in accelerometer in a selected number of monitoring nodes exceeds a certain minimum threshold, during a certain minimum time, these monitoring nodes provide alerts to the base station. The base station software will decide based on the number of monitoring nodes providing alerts whether to wake up the entire network of acceleration sensing nodes over the radio. The monitoring nodes are selected based on their location and amount of environmental noise. Ground-level nodes may be suitable candidates, provided they are sufficiently far removed from disturbance sources such as heavy traffic. The selection of monitoring nodes can be done dynamically from the base station. This allows for example to disable the monitoring function on nodes that report unusually high numbers of false alarms. To that purpose, the hardware and software of the monitoring nodes are identical to that of the non-monitoring nodes. The monitoring function is an optional function which can be enabled or disabled during operation by the base station. After the nodes have been woken up the recorded data is read out by the base station which sequentially requests the data of each sensor module.

The parameters for this wake-up mechanism can be fully configured from the base station and wirelessly updated at

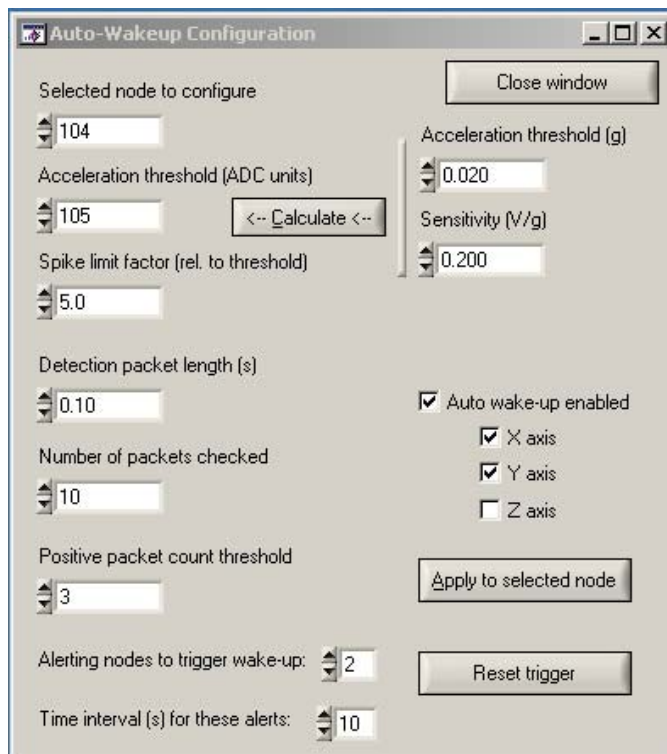

Fig. 7. User interface showing per-node tunable parameters of the earthquake wake-up procedure.

any time. Fig. 7 shows the user interface with the parameters that can be configured individually for each node as well as the global wake-up threshold settings.

To support this scenario, the wake-up of (most of) the acceleration sensing nodes to initiate measurement has to be done over the radio link. This also implies that it is possible to wake up the nodes via the base station over the radio link at any chosen time independent of the presence of an earthquake, which is a desired functionality for testability and monitoring of the system. It also means that all modules in the network will be woken up during a detected event, even if the accelerations locally at some modules have not (yet) reached a value exceeding the trigger threshold.

It is required to be able to record the early onset of an earthquake event, even before and certainly no later than 1 ms after it reaches a pre-set trigger threshold. In order to do this, the accelerometer is constantly running at  $3 \times 200$  Hz sample rate with the measurements recorded in a 54-second loop buffer. This requires an ultra low power sensor and readout. The power consumption of the 3D accelerometer and 3-channel readout operating continuously is  $125 \mu\text{A}$  at 3 V.

The node must be woken up within 54 seconds after the start of the recording of interest to avoid the loop buffer overflowing which would lead to data loss. To respond timely to an event triggered from the base station, the radio polling interval of the accelerometer modules is set to 15 seconds. This allows the event trigger to propagate sufficiently fast to the entire network to ensure the loop buffer contents containing the data for the event are preserved for all nodes. Once a node's loop buffer is full, recording will continue in a secondary 54-second buffer until the next event trigger. After an event, the data

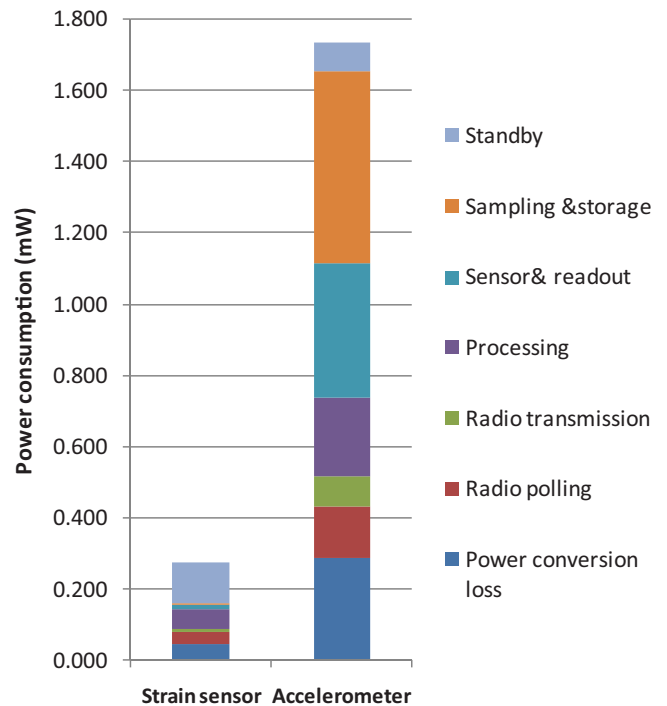

Fig. 8. Sensor module power consumption results.

must be wirelessly read out from each node to the base station one by one, a process which may take several minutes for multiple nodes. If a new event is detected before all the data of the first event is read out, the new event cannot be recorded since it would cause the loss of the data of the first event—a choice which could hypothetically be made from the base station if the relative importance of the second event were to outweigh that of the first event. In practice, the time interval between actual events is expected to be sufficiently large that this limitation is not a problem for the application.

2) *Strain Sensor Modules*: The main measurement scenario for the strain sensor is a periodic readout. Samples are taken at a configurable sample rate between 10 seconds and 18 hours. The strain sensor modules use a radio polling interval of 60 seconds. This also allows manual wake-up functionality from the base station, again useful for monitoring and testability reasons. Unlike for the accelerometers, in the case of the strain sensors the sensor and read-out ASIC can be entirely shut down between measurements. This results in a lower power consumption and longer battery life. Since a typical building requires many more strain sensors than accelerometer modules, it is useful for the strain sensors to have the longest battery service life.

### III. RESULTS

#### A. Power Consumption

Fig. 8 shows the measured power consumption in the sensor modules for strain sensor and accelerometer modules and how it is broken down according to the different components of the system. The total average power consumption is  $0.274 \text{ mW}$  for the strain sensor modules and  $1.73 \text{ mW}$  for the accelerometer modules. With the abovementioned C-cell size battery this

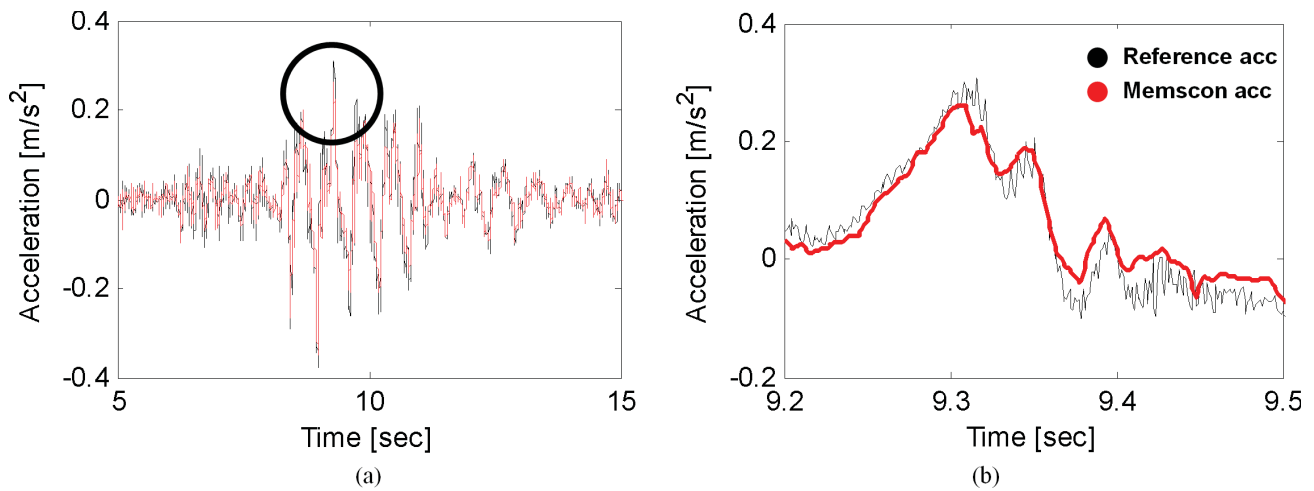

Fig. 9. (a) Wireless sensor module acceleration signal output (lowpass-filtered for noise reduction) on full-scale model with simulated earthquake and comparison to reference accelerometer (traditional piezoelectric uniaxial-wired accelerometer). (b) Enlargement of the peak of the signal.

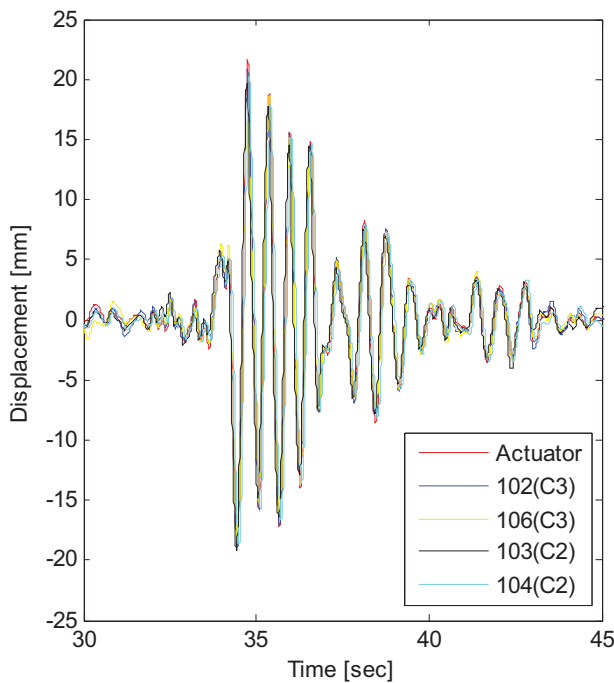

Fig. 10. Calculated displacements (by double integration) from wireless sensor module acceleration output on full-scale model and comparison to the actual applied displacement from the actuator providing the simulated earthquake.

implies a battery life of 12 years for the strain sensor modules and 2 years for the accelerometer modules.

**B. Laboratory Validation**

Because it is not feasible to create controllable earthquake-like conditions in an actual building, the validation of the modules is done in the laboratory on a full-scale reinforced concrete frame, reproducing a subcomponent of the building. During the laboratory tests, actuators apply to the frame the loads transmitted by the rest of the building as well as simulated earthquake conditions based on previously recorded signals from real earthquakes [8].

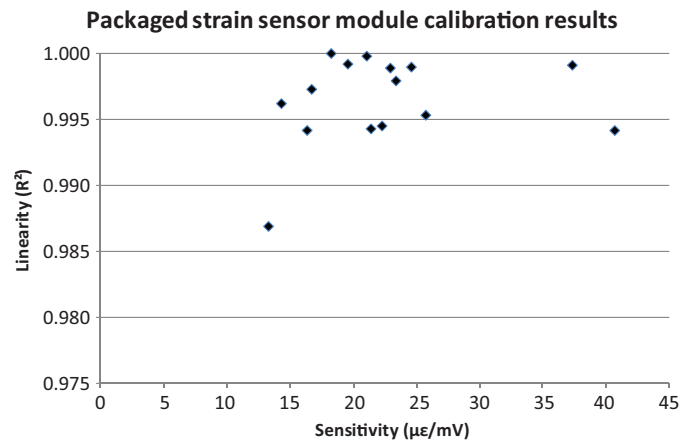

Fig. 11. Calibration results on strain sensor front-end modules.

Fig. 9 shows an example result of the laboratory validation of the accelerometer modules on the full-scale building model during a simulated earthquake compared to the output of a traditional wired piezoelectric uniaxial accelerometer (model PCB 393C) used as reference. Compared to the reference signal, the signal from the wireless accelerometer modules is smoother due to the lowpass filtering post-processing at 25 Hz that has been performed in the data acquisition software in this case, as required by the building monitoring application. Otherwise the signals correlate well. However, the most interesting result for the monitoring application is the comparison of the calculated displacement through double integration of the acceleration signals to the actual displacement applied from the actuator. As can be seen in Fig. 10, the calculated displacements from the measurements of the wireless acceleration sensor modules correspond very well to the actual displacement.

The strain sensor front-end modules have been validated in the laboratory in a specially constructed calibration setup in which a known strain is applied to the module and its output is recorded. The resulting sensitivity and linearity parameters are shown in Fig. 11. All sensors are highly linear, but there

is a significant spread in the sensitivity, which means that individual calibration of each sensor is required.

#### IV. CONCLUSION

The presented wireless system for building monitoring takes advantage of the unique features of custom-developed MEMS sensors and read-out ASIC combined with an optimized network and module architecture, to realize a solution which offers long battery lifetime and potentially low cost in manufacturing, installation and maintenance, while providing high-quality sensor data at the right time.

#### ACKNOWLEDGMENT

The authors would to thank N. Saillen, B. Wenk, M. Colin, M. Pozzi, A. Garetos, Y. Stratakos, M. Bimpas, A. Amditis, Manos, D. Bairaktaris, S. Frondistou-Yannas, S. Camarinopolos, V. Kalidromitis, P. Marmaras and D. Ulieru for their collaboration that has made this work possible.

#### REFERENCES

- [1] M. Pozzi, D. Zonta, W. Wang, and G. Chen, "A framework for evaluating the impact of structural health monitoring on bridge management," in *Proc. 5th Int. Conf. Bridge Maintenance, Safety Manage.*, Philadelphia, PA, Jul. 2010, p. 161.
- [2] J. P. Lynch and K. J. Loh, "A summary review of wireless sensors and sensor networks for structural health monitoring," *Shock Vibrat. Dig.*, vol. 38, no. 2, pp. 91–128, 2006.
- [3] D. Zonta, M. Pozzi, and P. Zanon, "Managing the historical heritage using distributed technologies," *Int. J. Arch. Heritage*, vol. 2, no. 3, pp. 200–225, 2008.
- [4] M. Kruger, C. U. Grosse, and P. J. Marron, "Wireless structural health monitoring using MEMS," *Key Eng. Mater.*, vols. 293–294, pp. 625–634, Sep. 2005.
- [5] A. Amditis, Y. Stratakos, D. Bairaktaris, M. Bimpas, S. Camarinopolos, and S. Frondistou-Yannas, "Wireless sensor network for seismic evaluation of concrete buildings," in *Proc. 5th Eur. Workshop Struct. Health Monitor.*, Sorrento, Italy, Jun.–Jul. 2010.
- [6] J. Santana, R. van den Hoven, C. van Liempd, M. Colin, N. Saillen, and C. Van Hoof, "A 3-axis accelerometer and strain sensor system for building integrity monitoring," in *Proc. 16th Int. Conf. Solid-State Sensors, Actuat., Microsyst.*, Beijing, China, Jun. 2011, pp. 36–39.
- [7] A. Amditis, Y. Stratakos, D. Bairaktaris, M. Bimpas, S. Camarinopolos, and S. Frondistou-Yannas, "An overview of MEMSCON project: An intelligent wireless sensor network for after-earthquake evaluation of concrete buildings," in *Proc. 14th Eur. Conf. Earthquake Eng.*, Aug.–Sep. 2010.
- [8] D. Trapani, D. Zonta, F. Larcher, A. Amditis, N. Bertsch, M. Bimpas, A. Garetos, N. Saillen, J. Santana, T. Sterken, Y. Stratakos, T. Torfs, and D. Ulieru, "Laboratory validation of MEMS-based sensors for post-earthquake damage assessment," in *Proc. 8th Int. Workshop Struct. Health Monitor.*, Stanford, CA, Sep. 2011, pp. 2165–2172.



**Tom Torfs** received the Bachelor's degree in electronics engineering from KIH De Nayer, Sint-Katelijne-Waver, Belgium, and the Master's degree in engineering-biomedical technology from KU Leuven, Leuven, Belgium, in 2001 and 2010, respectively.

He has been with the Interuniversity Microelectronics Centre (IMEC), Leuven, Belgium, as a Systems Researcher, since 2001, where he is involved in designing compact wireless autonomous systems based on IMEC wireless, sensor and packaging

technologies, with a focus on sensors for biomedical applications and body area networks. He has authored or co-authored over 50 papers in journals, 9 as the first author. He holds two patents.

Mr. Torfs was a recipient of the Best Paper Award at the BioCAS Conference in 2010 and the Smart Systems Integration Conference in 2009.



**Tom Sterken** received the Diploma degree in electrical engineering from the University of Ghent, Belgium, and the Ph.D. degree in design, modelling, and fabrication of miniature power generators based on microelectromechanical system technology from KU Leuven, Leuven, Belgium, in 2001 and 2009, respectively.

He was with the Interuniversity Microelectronics Centre, Leuven, Belgium, from 2002 to 2008. He is currently with the Centre for Microsystems Technology Research Group, University of Ghent, where he is researching ultrathin chip packaging and stretchable electronics. He has authored or co-authored over 45 technical publications.



**Steven Brebels** received the M.S. degree in electrical engineering from the University of Leuven, Leuven, Belgium, in 1994 and is currently pursuing the Ph.D. degree with the Interuniversity Microelectronics Centre (IMEC), Leuven, Belgium.

His current research within the RF Component Design and Modeling Group, IMEC, is directed to integrated circuits and antennas in thin-film and 3-D stacked modules. His current research interests include microwave and millimeter-wave components and integrated antennas.

Mr. Brebels was a co-recipient of the IEEE Microwave Prize in 2003.



**Juan Santana** obtained the M.S. degree in semiconductor devices from the University of Lancaster, Lancaster, U.K.

He joined the Engineering Department, University of Lancaster, in 1992. In 1997, he joined CINVESTAV, a research center in Mexico City, Mexico. From 1998 to 2001, he was the Director of the Semiconductor Technology Center, CINVESTAV. He was a commissioned engineer in several ASIC projects for automotive applications for ATMEL Corp., Columbia, MD. In 2001, he joined the Motorola Center for Semiconductor Technology, Puebla, Mexico. He has been with the Holst Centre, The Netherlands, Eindhoven, since 2006. He has authored or co-authored more than 30 papers in international journals. He has supervised several M.Sc. dissertations and holds one patent.



**Richard van den Hoven** received the Bachelor's degree in electronics engineering from Fontys University of Applied Sciences, Eindhoven, The Netherlands, in 2000, and the Master's degree with the thesis "A Pre-correction Method for Improved Static Linearity Using Parallel DACs" from the Technical University, Eindhoven, in 2006, where he was with the Mixed Signal and Micro Electronics Group.

He joined Philips Semiconductors (NXP), Eindhoven, The Netherlands, in 2006. Since 2007, he has been with the Holst Centre, Eindhoven, The Netherlands, and is involved in research on ASIC design of analog-to-digital conversion and capacitive readout. He has authored or co-authored four publications and holds one patent.



**Vincent Spiering** received the M.Sc. degree in applied physics in 1989 and the Ph.D. degree in microsystems in 1994, both from the University of Twente, Enschede, The Netherlands.

His post-doctoral research was on applied R&D and project management on microfluidic systems. He co-founded TMP in 1996 and C2V in 2003, where he was the Vice-President of Marketing. He is currently the Manager of Operations, MEMS and Micro-GC, Thermo Fisher Scientific, Enschede, The Netherlands. He has authored or co-authored more

than 50 papers in journals and international conferences, on microelectro-mechanical system technological and commercial issues.



**Davide Trapani** received the M.S. degree in civil engineering in 2010 from the University of Trento, Trento, Italy, where he is currently pursuing the Ph.D. degree in structural engineering.

He was a Research Assistant with the Intelligent Infrastructure Group, University of Trento, from 2010 to 2011, where he was involved in research on laboratory validation of smart sensor technologies, including wireless and fiber optic sensors. He has authored or co-authored 14 technical papers in international journals and conference proceedings.



**Nicolas Bertsch** received the Bachelor's degree in physics of semiconductor devices from the Grenoble National Engineering School for Physics (INPG Group), Grenoble, France.

He joined MEMSCAP in 2000 as an Engineer, where he has held various positions from sales and business development activities in Asia to Corporate R&D Director in 2006, and since 2010, he has been the Chief Operating Officer.



**Daniele Zonta** received the Doctorate degree in structural mechanics from the University of Bologna, Bologna, Italy, in 2000.

He was a Post-Doctoral Researcher with the University of California, San Diego, from 2000 to 2001. He has been a Visiting Scholar with the University of Michigan, Ann Arbor, in 2010, and Princeton University, Princeton, NJ, in 2009 and 2011. Since 2001, he has been an Assistant Professor of structural engineering with the University of Trento, Trento, Italy, where he is teaching precast concrete bridge

design and smart structures. He has authored or co-authored over 100 papers in journals and conferences. His research interests include bridge management, Bayesian decision-making, structural health monitoring, fiber optics and smart sensor technologies, all as applied to civil structures.